

F 015 427 031

Stand } 10-08-31  
Issue }

**Fig. /Abb. 1**

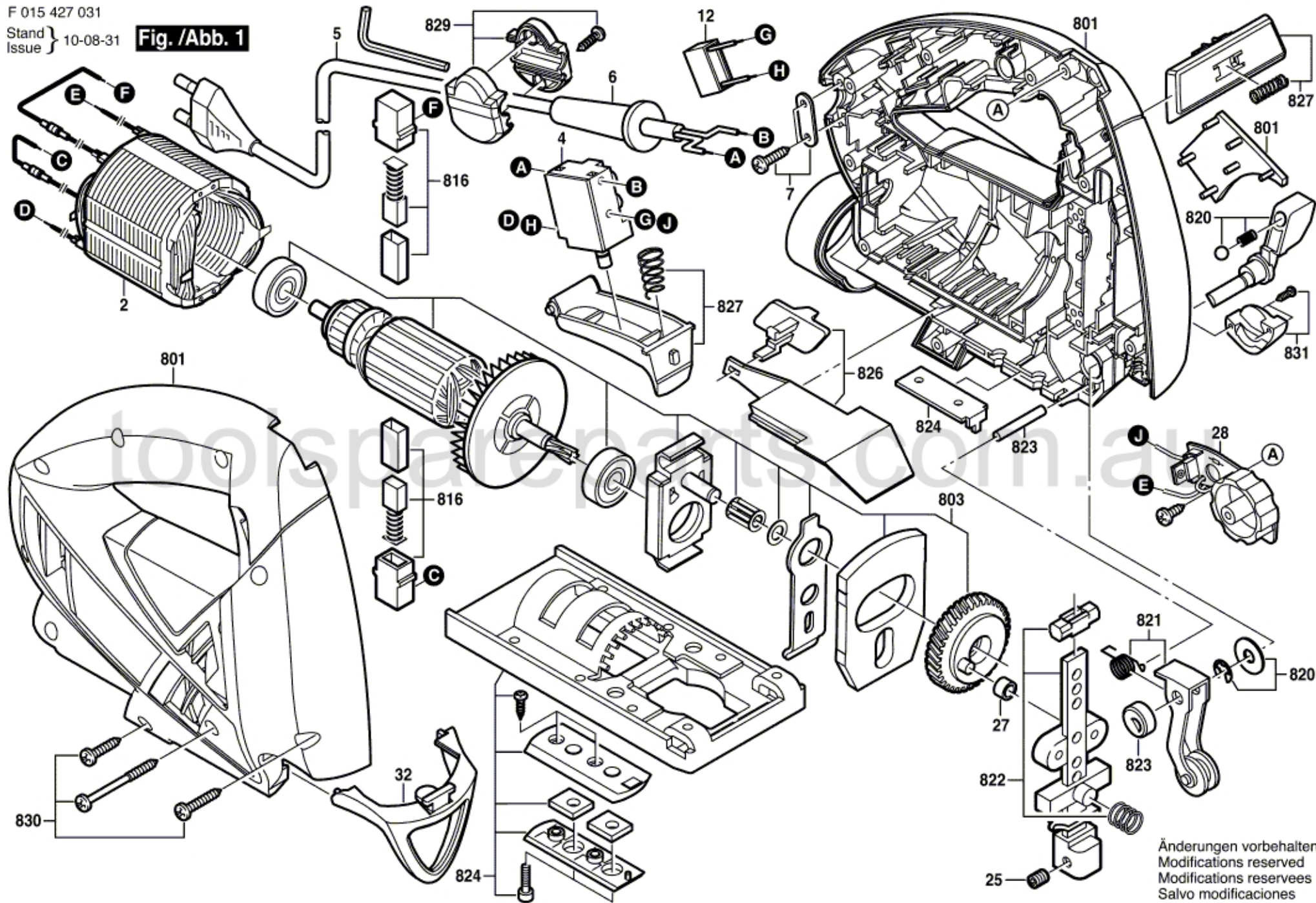

Änderungen vorbehalten  
Modifications reserved  
Modificaciones reservadas  
Salvo modificaciones